

零件图	成品图	客户图
		○

REVISION DATA				
REV	ECN No.	DESCRIPTION	NAME	DATE
A0		NEW DRAWING	D.Y.Y	2023-04-08

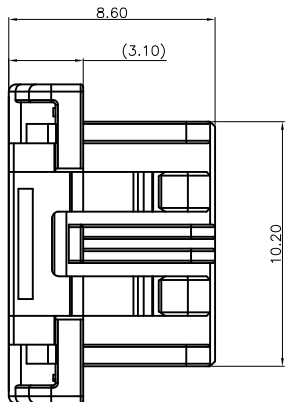
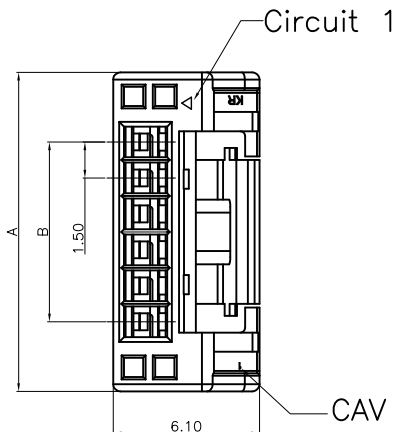
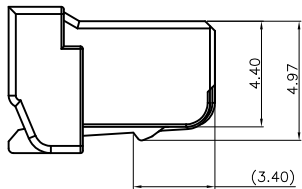

Technical Data

Current rating:3A AC/DC.
Voltage rating:100V AC/DC
Temperature range:-40°C~+105°C.
Contact resistance:20MΩ Max.
Insulation resistance:500MΩ Min.
Withstanding voltage: 500V AC/minute.
Material:PBT,UL94V-0.
Mating Terminal:VHSBXXP0705A

15P	26.80	21.00	23.70
14P	25.30	19.50	22.20
13P	23.80	18.00	20.70
12P	22.30	16.50	19.20
11P	20.80	15.00	17.70
10P	19.30	13.50	16.20
9P	17.80	12.00	14.70
8P	16.30	10.50	13.20
7P	14.80	9.00	11.70
6P	13.30	7.50	10.20
5P	11.80	6.00	8.70
4P	10.30	4.50	7.20
3P	8.80	3.00	5.70
2P	7.30	1.50	4.20
Poles	A	B	C

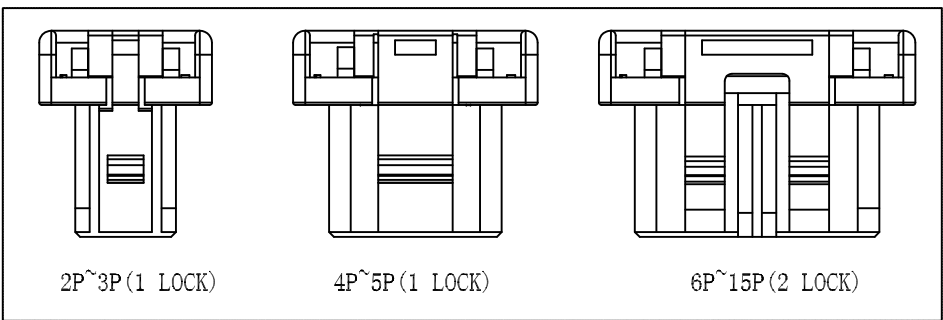

VHS	H	11	XXX	A	X	N	R	01
H PH 1.5		Pin位数 Product Type 11 Single row 12 Double row	Pin位数 No. of Positions XXX Positions	材质 A PBT B PA-66 D LCP	颜色 B Black W White N Natural	特征流水码 N 常规 W 带柱 O 外柱 L 带卡钩 C 带翅膀	R ROHS L 无卤	Series No.

ANYCONN® 东莞市恩康电子科技有限公司
DONGGUAN ENKANG ELECTRONICS TECHNOLOGY CO.,LTD

www.anyconn.com
TEL:+86(0)769 8904 9672
FAX:+86(0)769 8904 9671
E-MAIL:sales@anyconn.com

TOLERANCE	DATE :	2023-04-08	TITLE:	Pitch1.50 H8.60 Housing			
ANGLE ±5°	DRAWN :	D.Y.Y	PART NO: VHSH11XXXAXNR01				
X.XXX ±0.10	CHECKED :						
X.XX ±0.20	APPROVED :						
X.X ±0.30	PROJECTON		REV: A0	UNIT: mm	SCALE: 1:1	SIZE: A4	PAGE: 1/1
X. ±0.50							

零件图	成品图	客户图
		○

REVISION DATA				
REV	ECN No.	DESCRIPTION	NAME	DATE
A0		NEW DRAWING	D.Y.Y	2023-04-10

Technical Data

- 1.Current rating:3A AC/DC.
- 2.Voltage rating: 100V AC/DC
- 3.Temperature range: -40°C~+105°C
- 4.Insulation resistance: 500MΩ Min.
- 5.Withstanding voltage: 500V AC/ minute
- 6.Contact resistance: 30m Ω Max.
- 7.Applicable Wires: AWG#24~#28
Insulation O.D.:1.28mm MAX
- 8.Material: Phosphor Bronze
- 9.Finish: Gold or Tin plated over Nickel
- 10.Q'ty/Reel: 10,000 PCS/Reel
- 11.Mating Housing:VHSH11XXXAXNR01

Part No: VHSH XX P 0690A

Pin Plating
G0 Gold Flash
G1 Gold 1u"
SN Tin Plated

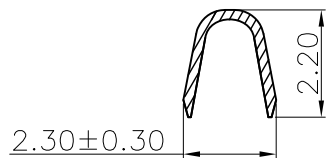
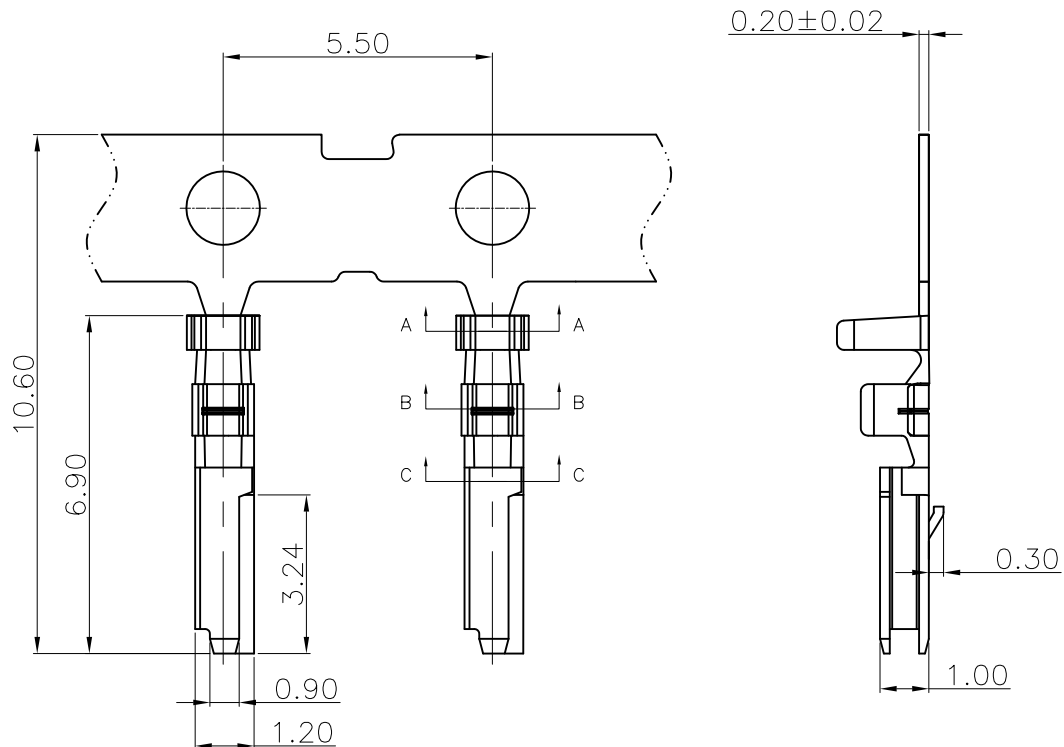

SECTION A-A



SECTION B-B

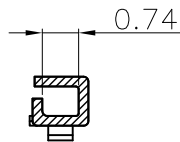

SECTION C-C

ANYCONN®
www.anyconn.com
TEL:+86(0)769 8904 9672
FAX:+86(0)769 8904 9671
E-MAIL:sales@anycom.tw

东莞市恩康电子科技有限公司

DONGGUAN ENKANG ELECTRONICS TECHNOLOGY CO.,LTD

TOLERANCE	DATE :	2023-04-10	TITLE:		
ANGLE ±5°	DRAWN :	D.Y.Y	PH1.50 Terminal		
X.XXX ±0.10	CHECKED :		PART NO: VHSHXXP0690A		
X.XX ±0.20	APPROVED :				
X.X ±0.30	PROJECTON		REV: A0	UNIT: mm	SCALE: 1:1
X. ±0.50			SIZE: A4	PAGE: 1/1	