

零件图	成品图	客户图
		○

REVISION DATA				
REV	ECN No.	DESCRIPTION	NAME	DATE
A0		NEW DRAWING	D.Y.Y	2023-04-13

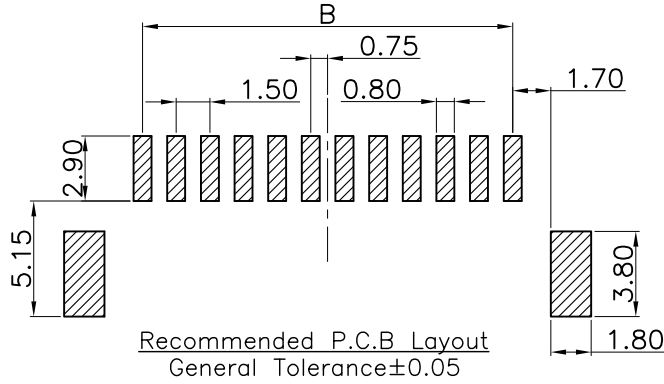
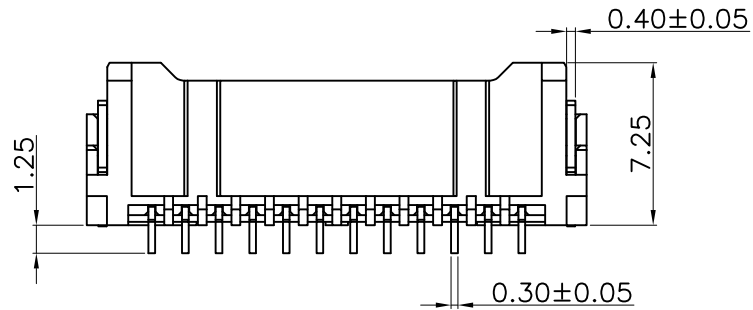
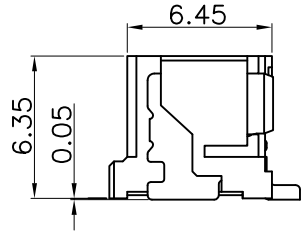
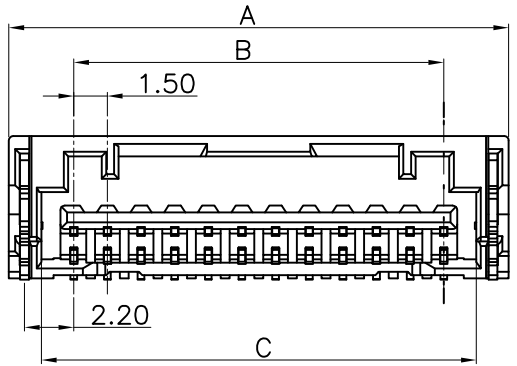
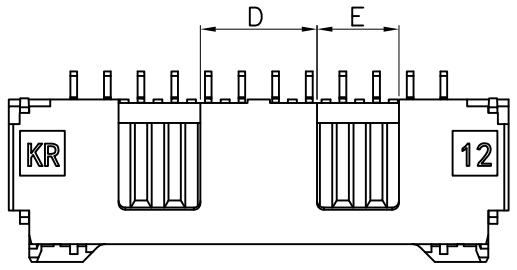

### Technical Data

Current rating:3A AC/DC.  
Voltage rating:100V AC/DC  
Temperature range:-40°C~+125°C.  
Contact resistance:20mΩ Max.  
Insulation resistance: 500MΩ Min.  
Withstanding voltage: 500V AC/minute.  
Material:  
Housing:PA9T, UL94V-0  
Pin:Phosphor Bronze  
Fitting Nail: Brass  
Plating: Gold or Tin Plated

15P	26.80	21.00	23.90	5.20	
14P	25.30	19.50	22.40	5.20	
13P	23.80	18.00	20.90	5.20	
12P	22.30	16.50	19.40	5.20	3.65
11P	20.80	15.00	17.90	5.20	
10P	19.30	13.50	16.40	3.20	
9P	17.80	12.00	14.90	3.20	
8P	16.30	10.50	13.40	2.50	3.25
7P	14.80	9.00	11.90	2.50	2.50
6P	13.30	7.50	10.40	2.30	2.15
5P	11.80	6.00	8.90	—	3.60
4P	10.30	4.50	7.40	—	3.30
3P	8.80	3.00	5.90	—	2.55
2P	7.30	1.50	4.40	—	1.85
PIN	A	B	C	D	E

WF	H	H	11	XXX	XX	X	X	N	H011
Pitch(mm) H 1.5	Angel Options R 90° D 180° S SMT H 卧式SMT	Product Type 11 Single row	No. of Positions XXX Poles	Pin Plating G0 Gold Flash SN Tin Plated T3 雾锡	Colour B Black W White N Natural	Insulator Material B PA66 D LCP F PA9T	W With peg N NO Peg L with lock T Fixed Tabs	Series NO.	

**ANYCONN®** 东莞市恩康电子科技有限公司  
DONGGUAN ENKANG ELECTRONICS TECHNOLOGY CO.,LTD

www.enkcom.com  
TEL:+86(0)769 8904 9672  
FAX:+86(0)769 8904 9671  
E-MAIL:sales@anyconn.com.tw

TOLERANCE	DATE : 2023-04-13	TITLE:
ANGLE ±5°	DRAWN : D.Y.Y	Wafer PH1.50 H6.35 Single Row H-SMT Type
X.XXX ±0.15	CHECKED :	PART NO: WFHH11XXXXXXXNH011
X.XX ±0.25	APPROVED :	
X.X ±0.38	PROJECTION	
X. ±0.50		REV: A0 UNIT: mm SCALE: 1:1 SIZE: A4 PAGE 1/2

零件图	成品图	客户图
		○

REVISION DATA				
REV	ECN No.	DESCRIPTION	NAME	DATE
A0		NEW DRAWING	D.Y.Y	2023-04-13

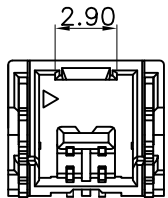

2P VIEW

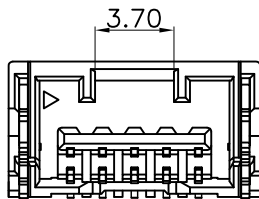

5P VIEW

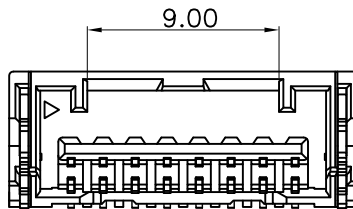

8P VIEW

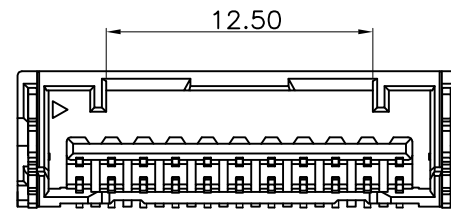

11P VIEW

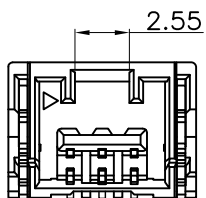

3P VIEW

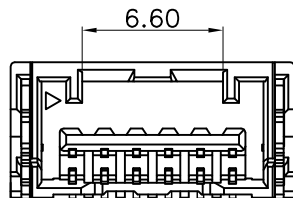

6P VIEW

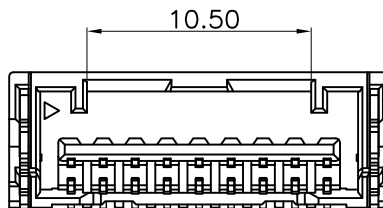

9P VIEW

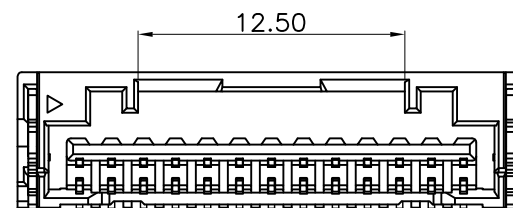

13P VIEW

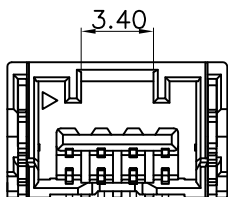

4P VIEW

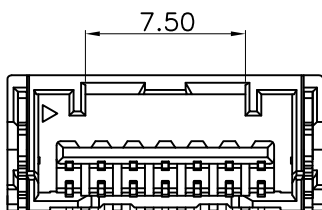

7P VIEW

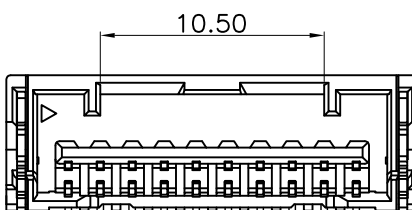

10P VIEW

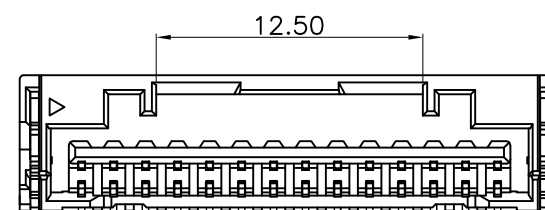

14P VIEW

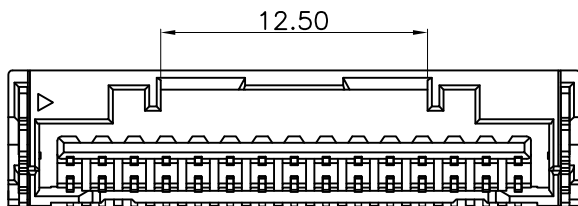

15P VIEW

**ANYCONN®** 东莞市恩康电子科技有限公司  
 www.enkcom.com  
 TEL:+86(0)769 8904 9672  
 FAX:+86(0)769 8904 9671  
 E-MAIL:sales@anycom.tw  
**DONGGUAN ENKANG ELECTRONICS TECHNOLOGY CO.,LTD**

TOLERANCE	DATE :	2023-04-13	TITLE:			
ANGLE ±5°	DRAWN :	D.Y.Y	Wafer PH1.50 H6.35 Single Row H-SMT Type			
X.XXX ±0.15	CHECKED :		PART NO: WFHH11XXXXXXXNH011			
X.XX ±0.25	APPROVED :		REV:	UNIT:	SCALE:	SIZE:
X.X ±0.38	PROJECTION		A0	mm	1:1	A4
X. ±0.50						PAGE 2/2